

10 Dallas Court Hallam, Victoria
3803 ABN 27 106 103 315
www.aggdoors.com.au
enquiries@aggdoors.com.au
(03) 8789 1385



Genuine TRC2

Programming of your new Remote control

Receiver with Digital screen

1. Press the OK button on your receiver twice. The screen displays "PARA".
2. Press the "-" button on your receiver twice. The screen displays "RADIO".
3. Press the "OK" button on your receiver once. The screen displays "ADJ STRT".
4. Press the "OK" button on your receiver once. The screen displays "Hide Button".
5. Press both buttons on your new remote control at the same time. Keep them pressed down. The screen displays "Released".
6. Let the buttons go. The screen displays "Desired Button".
7. Press a button on your new remote control. The screen displays "OK".
8. Wait 10 seconds.
9. Your new remote control is programmed.



Programming of your new Remote control

Receiver without Digital screen

1. Open the casing of your receiver. It is located next to your motor.
2. On the receiver circuit board, press the programming button (SW1). The LED light of the receiver blinks. Let the button go.
3. Press both buttons on your new remote control at the same time. Let them go. The LED light of the receiver remains lit fixedly.
4. Press the left button on your new remote control. Let it go. The LED light of the receiver blinks.
5. Wait 5 seconds. The LED light of the receiver turns off.
6. Repeat this procedure for the right button of your new remote control. This time, use the programming button SW2.
7. Wait 10 seconds.
8. Your new remote control is programmed.

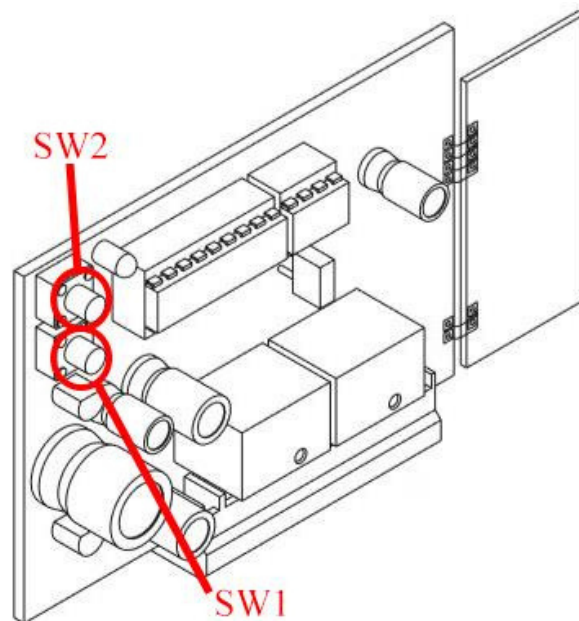

Coding via existing coded remote

Locate a remote already coded to & working the device. Be within 3 meters of the gate control box.

Original Remote: Press hidden button on back of remote with a pin or paper clip OR press Button 1 & 2 together until remote LED lights.

Original Remote: Momentarily press button that opens device.

This puts the device receiver into learning Mode

New Remote: Press hidden button on back of remote with a pin or paper-clip or press buttons 1 & 2 together until remote LED lights.

This teaches the receiver the additional code to remember

